

Kwikstrut

STAINLESS STEEL

Innovative yet simple

Quality products that reduce design time and installation costs in highly corrosive environments.

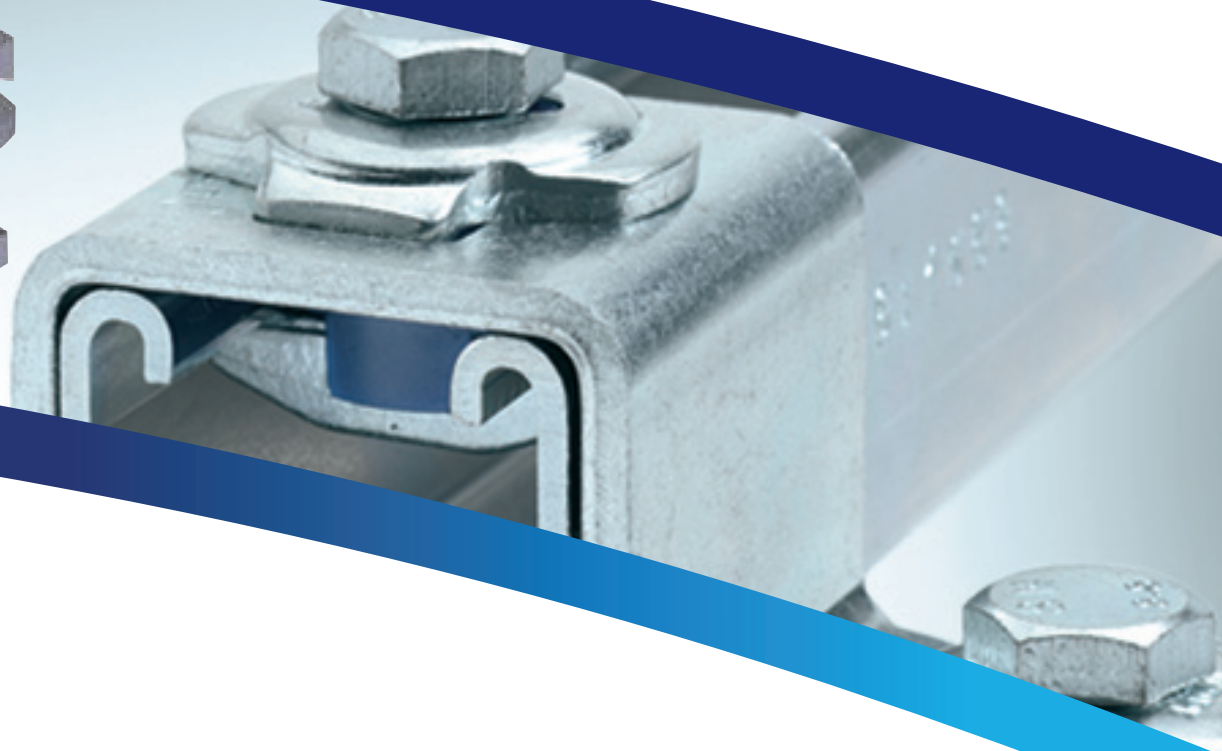
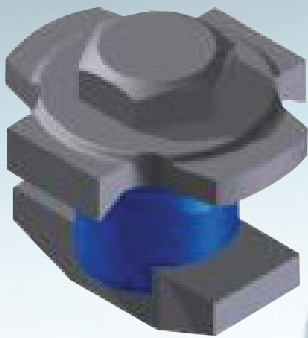

Product Advantages

Renown names

TYCO and KWIKSTRUT are renowned names for products that reflect bespoke quality. Products are offered globally through Tyco Fire Protection Products, a rapidly expanding division within Tyco International.

Quality goods

As most of our manufacturing facilities are ISO9001 certified and our distribution facilities are ISO9002 certified, we can proudly say we deliver quality goods through quality channels.

Short lead times

With well over 20,000 different products in stock in our Regional Distribution Centres and local warehouses, most of our products are supplied from stock. Custom made materials and assemblies combining different products are available at very short notice.

Benefits

- Wide range of products for different applications
- Lower installation costs
- Corrosion protection
- Available in Stainless Steel 316 & 304 (on request)
- Single piece design, no nut and washer to assemble
- Reduced installation time
- Complete fitting package
- Improved safety at construction site



Overhead installation with one hand

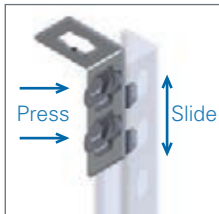

Spring-lock adjustment of fittings on channel



Reduction of required parts

From design...to build

In order to meet our clients' requirements and the industrial standards for Stainless Steel support systems, Tyco FPP offers CAD drawings and mechanical design services that help to ensure that our KWIKSTRUT-Stainless Steel support solutions and systems are applied in the best possible manner during the concept, design, installation and maintenance phase.

Our technical design services provide:

- Expansion and fix point force calculations
- Static linear material calculations of our channels
- Easy-to-follow, tagged 3D Isometric Drawings with complete Bill of Material (BOM) tables
- Assembly drawing for installation purpose
- CAD drawings
- Calculation tools
- Complete customer support solutions

With the support of our in-house engineering department, we can assist in the design of our customers' KWIKSTRUT Stainless Steel metal framing constructions, help with material take-off and selection of the right product for the right application. We can also assist with the calculation of loads on channel through our software package.

General Kwikstrut Installation



Step 1: Place Fitting

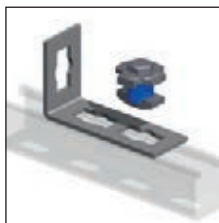

Step 2: Plug in

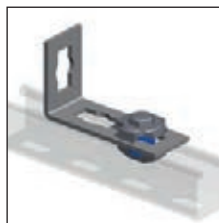

Step 3: Turn right

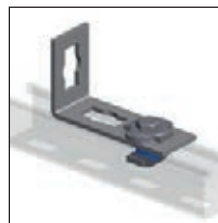

Step 4: Adjust

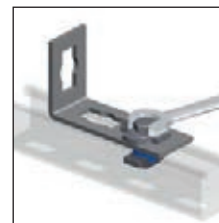

Step 5: Tighten

Square Washer Kwikstrut Installation



Step 1: Plug in



Step 2: Turn right



Step 3: Insert thread rod



Step 4: Tighten



Strong and robust

KWIKSTRUT Stainless Steel products guarantee maximum allowable loads in highly corrosive environments.



Reduced installation time & cost

The pre-assembled Three In One KWIKSTRUT channel nut enables installers to reduce the time taken to mount the metal framing systems, which translate into an overall reduced cost.



Customised design

KWIKSTRUT-Stainless Steel products are designed to engineer a total customised design solution.



Flexible and adjustable

KWIKSTRUT-Stainless Steel products can be used on a wide range of structures and angles and are demountable.



Easy and quick to use

KWIKSTRUT-Stainless Steel support systems consist of pre-assembled bolts, washers and nuts that can easily be fitted on channels with one hand, saving time and money when out in the field.



Fast delivery

KWIKSTRUT-Stainless Steel products are dispatched from our regional stocking centres, ensuring a quick response and optimised delivery times



Metal Framing System

Medium & Heavy Duty Framing System

Single Channel - Stainless Steel



1

Double Channel - Stainless Steel



2

Channel Accessories



3

Kwikstrut Channel Nuts - Stainless Steel



4

Kwikstrut Angle Fittings - Stainless Steel



5

Kwikstrut Channel Beam Clamps - Stainless Steel



6

Kwikstrut Special Fittings - Stainless Steel



7

Kwikstrut Channel Base Fittings - Stainless Steel



8

1 Single Channel - Stainless Steel

Kwikstrut Single Channel P3300

Material : Stainless Steel - 1.4404 (316L;A4) - EN 10088-2

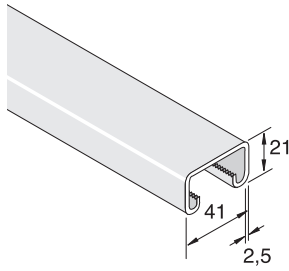

Art.Nr.	L mm	Kg 1 pcs.	
P3311146	6000	11.747	50

Kwikstrut Single Channel P3300T10

Material : Stainless Steel - 1.4404 - EN 10088-2

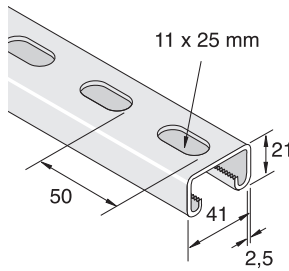

Art.Nr.	L mm	Kg 1 pcs.	
P3311346	6000	10.569	50

Kwikstrut Single Channel P1000

Material : Stainless Steel - 1.4404 - EN 10088-2

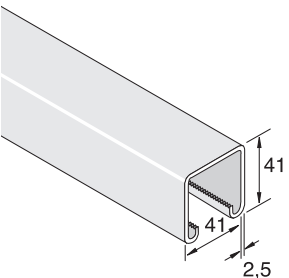
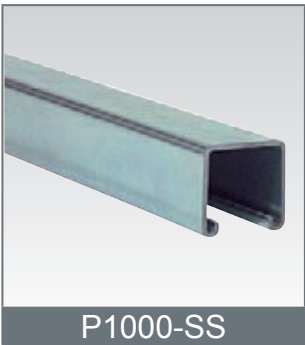

Art.Nr.	L mm	Kg 1 pcs.	
P1011146	6000	16.056	50

1.003

1

Single Channel - Stainless Steel

Kwikstrut Single Channel P1000T

Material : Stainless Steel - 1.4404 - EN 10088-2



P1000T-SS

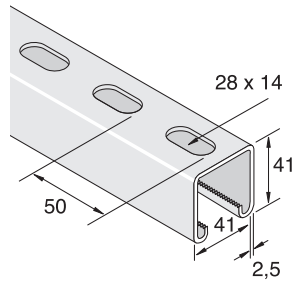

Art.Nr.	L mm	Kg 1 pcs.	
P1011246	6000	14.889	50

2

Double Channel - Stainless Steel

Kwikstrut Double Channel P3301T10

Material : Stainless Steel - 1.4404 - EN 10088-2



P3301T10-SS

Art.Nr.	L mm	Kg 1 pcs.	
P3321346	6000	21.188	25

Kwikstrut Double Channel P1001

Material : Stainless Steel - 1.4404 - EN 10088-2

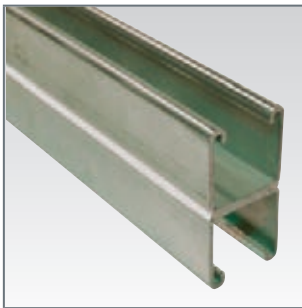

P1001-SS

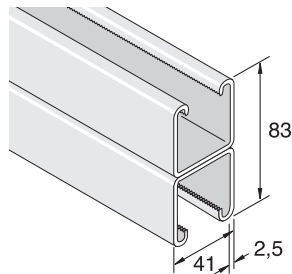

Art.Nr.	L mm	Kg 1 pcs.	
P1021146	6000	32.112	25

2 Double Channel - Stainless Steel

Kwikstrut Double Channel P1001T

Material : Stainless Steel - 1.4404 - EN 10088-2

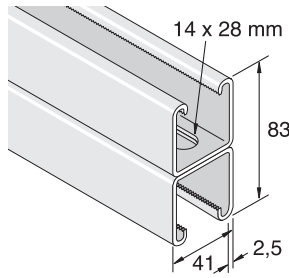

P1001T-SS

Art.Nr.	L mm	Kg 1 pcs.	
P1021246	6000	29.778	25

3 Channel Accessories

Endcaps for Kwikstrut Channel

Material : Polypropylene

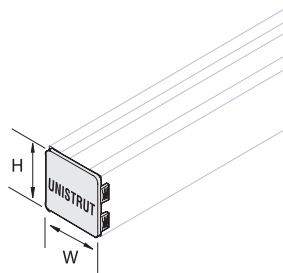

Endcap

Art.Nr.	Color	W mm	H mm	Kg /100	
1392196	white	41	21	0.3	100
1392197	Black	41	21	0.3	100
1392198	Bleu	41	21	0.3	100
1394196	White	41	41	0.5	100
1394197	Black	41	41	0.5	100
1394198	Bleu	41	41	0.5	100

Channel Socket

Material : Steel DD11 - EN 10111

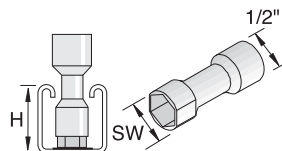

Channel Socket

Art.Nr.	H mm	SW	Kg /100	
17AF	41-83	M10	12.5	1
17AF/P3300	21	M10	12.5	1
19AF	41-83	M12	13.5	1

Kwikstrut Channel Nuts - Stainless Steel

Kwikstrut Uni Lock Channel Nut

Material : Stainless Steel 1.4404 - EN 10088-2005

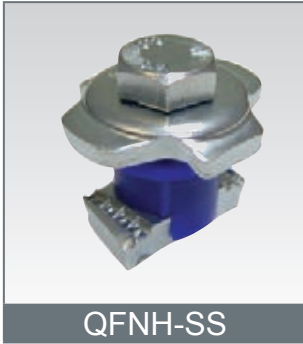

QFNH-SS

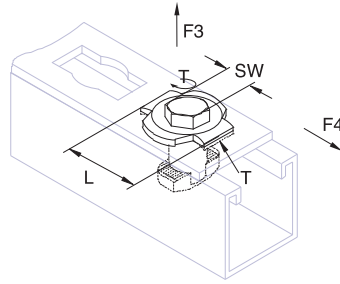

Art.Nr.	G	L mm	T mm	F3 kN	F4 kN	Tinst Nm	SW	/100	
1351118	M10	36	4	5	2.5	40	17	8	50

Kwikstrut Channel Nut with Square Washer

Material : Stainless Steel 1.4404 - EN 10088-2005

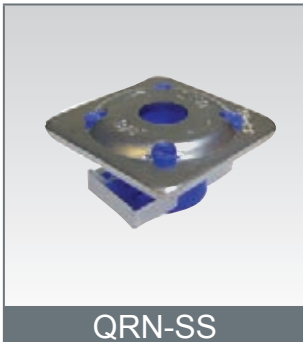

QRN-SS

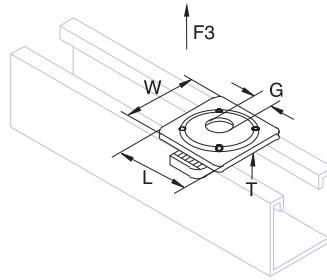

Art.Nr.	G	L mm	W mm	T mm	F3 kN	/100	
1352621	M6	40	40	2.5	5	6.4	50
1352822	M8	40	40	2.5	5	6	50
1352021	M10	40	40	2.5	5	5.9	50
1352221	M12	40	40	2.5	5	5.3	50

Kwikstrut Channel Nut with Plastic Washer

Material : Stainless Steel 1.4404 - EN 10088-2005; Washer PA

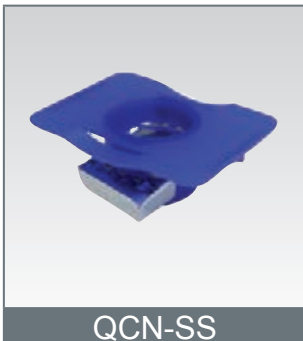

QCN-SS

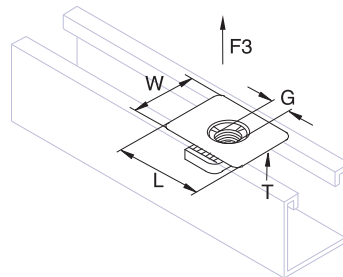

Art.Nr.	G	L mm	W mm	T mm	F3 kN	/100	
1351632	M6	46	35	0.8	5	3	50
1351832	M8	46	35	0.8	5	2.9	50
1351032	M10	46	35	0.8	5	2.8	50
1351232	M12	46	35	0.8	5	2.6	50

5 Kwikstrut Channel Nuts - Stainless Steel

Kwikstrut I-fitting

Material : Stainless Steel 1.4404 - EN 10088-2005

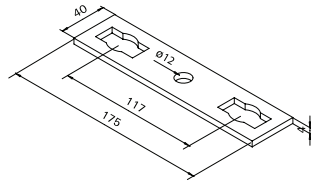

QFI-SS

Art.Nr.	L mm	W mm	T mm	Number of Holes	Kg /100	
1350147	175	40	4	1&1	16.7	100

Kwikstrut Flat Angle Fitting 90°

Material : Stainless Steel 1.4404 - EN 10088-2005

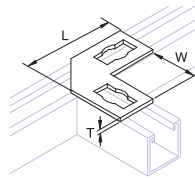

QFA-SS

Art.Nr.	L mm	W mm	T mm	Number of Holes	Kg /100	
1350125	92	52	4	1&1	12.5	25

Kwikstrut T-fitting

Material : Stainless Steel 1.4404 - EN 10088-2005

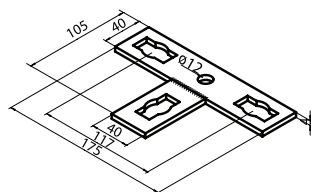

QFT-SS

Art.Nr.	L mm	W mm	T mm	Number of Holes	Kg /100	
1350146	175	105	4	1&2	23.6	25

Kwikstrut Cross Fitting

Material : Stainless Steel 1.4404 - EN 10088-2005

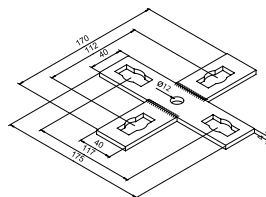
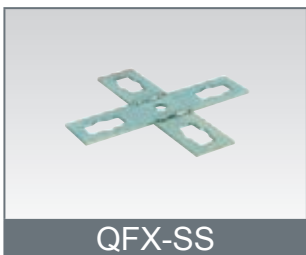

QFX-SS

Art.Nr.	L mm	W mm	T mm	Number of Holes	Kg /100	
1350145	175	170	4	2&2	29.5	50

Kwikstrut Angle Fittings - Stainless Steel

Kwikstrut Flat Angle Fitting 90°

Material : Stainless Steel 1.4404 - EN 10088-2005

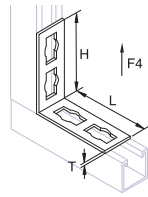
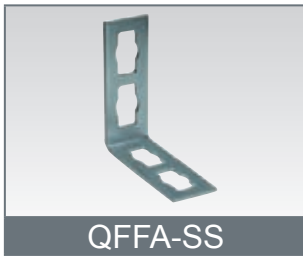

Art.Nr.	L mm	H mm	T mm	F4 kN	Number of Holes	/100	
1359025	63	63	4	2.5	1&1	10.7	25
1359035	63	110	4	2.5	1&2	14.5	25
1359045	110	110	4	4	2&2	18.3	25

Kwikstrut Flat Angle Fitting 135°

Material : Stainless Steel 1.4404 - EN 10088-2005

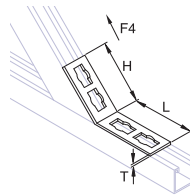

Art.Nr.	L mm	H mm	T mm	F4 kN	Number of Holes	/100	
1353535	63	110	4	2.5	1&2	14.5	25
1353545	110	110	4	4	2&2	18.3	25

Kwikstrut Angle Fitting 90°

Material : Stainless Steel 1.4404 - EN 10088-2005

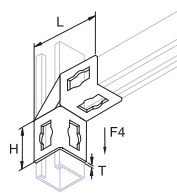

Art.Nr.	L mm	H mm	T mm	F4 kN	Number of Holes	/100	
1359055	103	58	4	2.5	2&2	25.2	10
1359065	150	105	4	4	4&4	41.7	10

5 Kwikstrut Angle Fittings - Stainless Steel

Kwikstrut Angle Fitting 135°

Material : Stainless Steel 1.4404 - EN 10088-2005



QFA 135-SS

Art.Nr.	L mm	T mm	F4 kN	Number of Holes	kg /100	
1353565	103	4	4	4&4	39.7	10

6 Kwikstrut Channel Beam Clamps - Stainless Steel

Kwikstrut Channel Beam Clamps

Material : Stainless Steel - 1.4401 - EN 10088-2

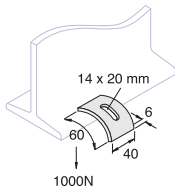

C711-SS

Art.Nr.	F2 kN	kg /100	
C711SS	1	10	50

Kwikstrut Channel Beam Clamps

Material : Stainless Steel - 1.4404 - EN 10088-2

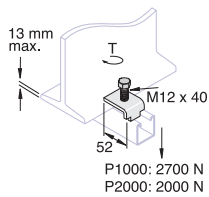

P1386-SS

Art.Nr.	Tinst Nm	kg /100	
P1386SS	70	10.3	50

Kwikstrut Channel Beam Clamps - Stainless Steel

Kwikstrut Channel Beam Clamps

Material : Stainless Steel - 1.4404 - EN 10088-2

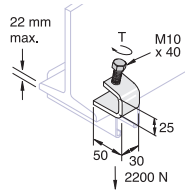

Art.Nr.	Tinst Nm	Kg /100	
P1272SS	10	18.7	50

Kwikstrut Channel Beam Clamp

Material : Stainless Steel - 1.4404 - EN 10088-2

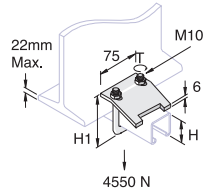

Art.Nr.	H mm	Tinst Nm	Kg /100	
P2785SS	21-41	22	25.7	25
P2786SS	62-83	22	25.7	20

Kwikstrut Channel Beam Clamps

Material : Stainless Steel - 1.4404 - EN 10088-2

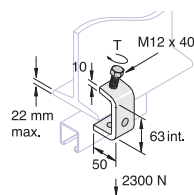



Art.Nr.	Tinst Nm	Kg /100	
P1271SS	20	47.7	25

7 Kwikstrut Special Fittings - Stainless Steel

Kwikstrut Angle T-fitting

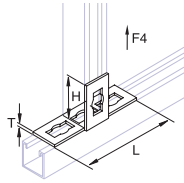
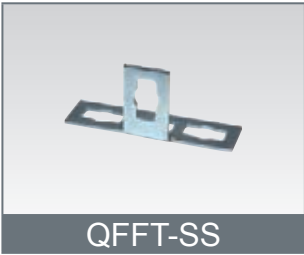
Material : Stainless Steel 1.4404 - EN 10088-2005



Art.Nr.	L mm	H mm	T mm	F4 kN	Number of Holes	Kg /100	
1350115	150	66	4	2.5	1&3	18.9	25

Kwikstrut Cross Fitting

Material : Stainless Steel 1.4404 - EN 10088-2005

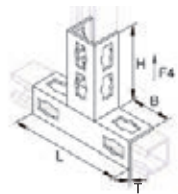

Art.Nr.	L mm	H mm	T mm	F4 kN	Number of Holes	Kg /100	
1354118	175	108	4	4	6&4	66.9	25

Kwikstrut U Shaped Fitting

Material : Stainless Steel 1.4404 - EN 10088-2005

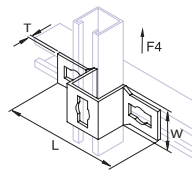

Art.Nr.	L mm	W mm	T mm	F4 kN	Number of Holes	Kg /100	
1354138	162	52	4	2.5	2&1	27.8	25

Kwikstrut Special Fittings - Stainless Steel

Kwikstrut 3 way Cross Fitting

Material : Stainless Steel 1.4404 - EN 10088-2005

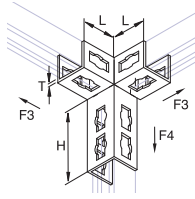

QFCL-QFCR-SS

Art.Nr.	L mm	H mm	T mm	F3 kN	F4 kN	Number of Holes	kg /100	
1354113	61	108	4	2.5	4	6&3&3	67.8	10
1354114	61	108	4	2.5	4	6&3&3	67.8	10

Kwikstrut 4 way Cross Fitting

Material : Stainless Steel 1.4404 - EN 10088-2005

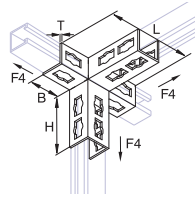

QFCD-SS

Art.Nr.	L mm	L1 mm	H mm	T mm	F4 kN	Number of Holes	kg /100	
1354179	172	61	108	4	4	6&3&4	98.3	10

Kwikstrut Rod Connection Fitting

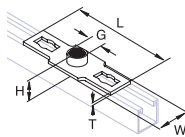

QFMP-SS

Art.Nr.	G	L mm	W mm	H mm	T mm	Number of Holes	kg /100	
1351626	M16	175	56	18	5	2	30.6	25
1352225	1/2"	175	56	20.5	5	2	29.9	25
1352825	3/4"	175	56	22.5	5	2	29.5	25

Kwikstrut Special Fittings - Stainless Steel

Kwikstrut Channel Coupler

Material : Stainless Steel 1.4404 - EN 10088-2005

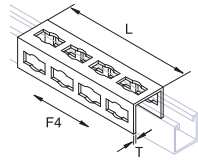
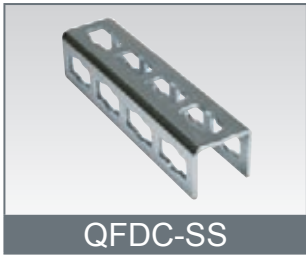



Art.Nr.	L mm	T mm	F4 kN	Number of Holes	kg /100	
1354148	195	4	4	12	53	10

8 Kwikstrut Channel Base Fittings - Stainless Steel

Kwikstrut Channel Base Fittings

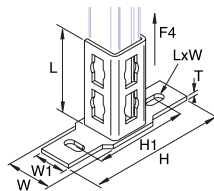
Material : Steel DD11 - EN 10111



Art.Nr.	L mm	W mm	W1 mm	H mm	H1 mm	T mm	LxW mm	F4 kN	Number of Holes	kg /100	
1354159	108	56	40	175	117	5	12.5x25	4	6	77	10

Kwikstrut Channel Base Fittings

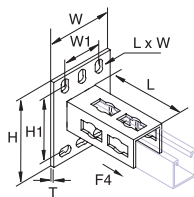

Art.Nr.	L mm	W mm	W1 mm	H mm	H1 mm	T mm	LxW mm	F4 kN	Number of Holes	kg /100	
1354158	108	100	62	130	100	5	12.5x20	4	6	75.2	10

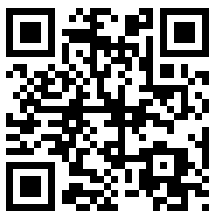

www.tfpemea.com

WORLDWIDE HEADQUARTERS

Tyco Fire Protection Products, 1400 Pennbrook Parkway, Lansdale, PA 19446,
Tel: +1 215-362-0700, (Toll Free) Tel: +1 800-558-5236, Fax: +1 800-877-1295, www.tyco-fire.com

ENSCHEDÉ
Kopersteden 1, P.O. Box 198,
7500 AD Enschede, The Netherlands,
Tel. +31 (0)53-428-4444
www.tfpemea.com

SINGAPORE
Tyco Fire Protection Products,
2 Serangoon North Avenue 5, #07-01, Singapore 554911
Tel. +65-6577-4360, Fax: +65-6481-8791
www.tyco-fire.com



TYFENKWKSS1012